







The **AV-REIL** is a self-contained runway end light operable via AC or solar power. The REIL system consists of two flashing light fixtures to easily identify the end of the runway. One fixture is positioned at each corner of the runway landing threshold.

Key Features:

- Multiple Power Options
- Integrated Battery System
- Complies with FAA photometrics

Standard			Optional		
	AC Input	Battery Backup		Solar	IR Output



Power Options

Depending upon your requirements, the REIL can be configured with the following power options:

- AC
- AC/Battery Backup
- AC/Battery Backup with Solar

Integrated Battery System

The main chassis contains a user-replaceable battery, and can easily add on a solar system option to increase the battery life.

Applications

- Portable for expeditionary, tactical, or temporary/ semi-permanent use
- IR or NVG mode option for covert operations



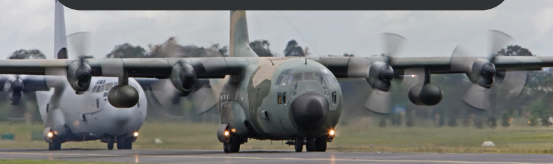

Runway End Identifier Light

AV-REIL

Light Characteristics

Light Source	LED
Available Colors	White
Intensity Adjustments	5 step intensity
Operating Time at Maximum Intensity	4 hours
LED Life Expectancy (hours)	> 100,000

Electrical Characteristics

Circuit Protection	Integrated
Operating Input Voltage	90-264VAC 50/60 Hz
Temperature Range	-40 to 122°F / -40 to 55°C

Solar Characteristics

Solar Module Type	Monocrystalline
Output (Watts)	100 (1 x 100W)
Charging Regulation	MPPT

Power Supply

Battery Type	Absorbent Glass Mat (AGM)
Battery Capacity (Ah)	25
Nominal Voltage (V)	12
Charger	Integrated
Rated Power	45 W
Input Voltage	90-264VAC 50/60 Hz

Physical Characteristics

Body Material	Painted steel and aluminum
Lens Material	Acrylic
Lens Design	Multi-LED optic
Mounting	2 through-holes with a 200mm circle
Height (inches/mm)	27.69 / 703
Length (inches/mm)	12.97 / 329
Width (inches/mm)	11.88 / 302
Mass (lb/kg)	55 / 25
Service Life	Up to 12 years

Environmental Standards

Wind Speed	REIL: Up to 300 mph / 483 kph Solar Panels: 125 mph / 201 kph
------------	--

Compliance

Quality Assurance	ISO 9001:2015
Trademarks	AVLITE® and AV-HMALS® are a registered trademark of Avlite Systems

Other

Warranty *	2 years
Available Options	Infrared Power Line Communication
Terms and Conditions	Please refer to product installation manual for further specifications. Warranty Terms and Conditions available at www.avlite.com .

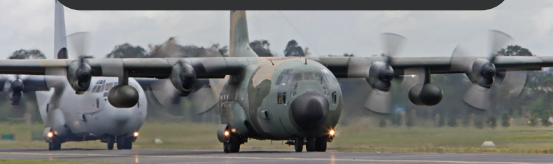

Technical Illustrations

Top View

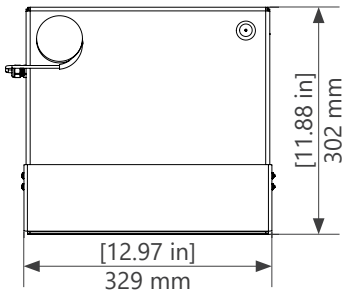

Front View

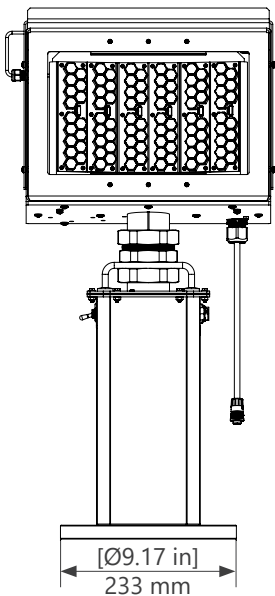

Side View

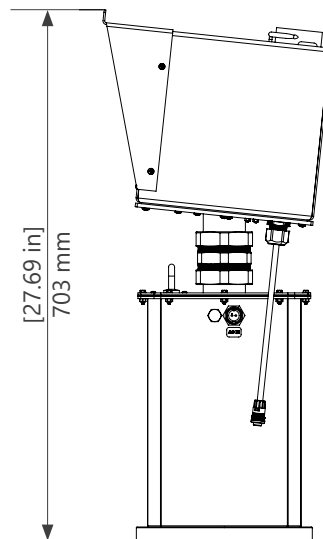

Ordering This Product

AV-REIL-[XX]-[XX]-[XX]



1 Product Number

2 Configuration

C10	Battery Only, No PLC, Cyclon Battery, 24 Volt Output
C11	Battery Only, PLC, Cyclon Battery, 24 Volt Output
C12	Battery Only, No PLC, Cyclon Battery, 24 Volt Output, Solar Input
C13	Battery Only, PLC, Cyclon Battery, 24 Volt Output, Solar Input

3 Color

FO	FAA Orange
YL	ICAO Yellow
DT	Desert Tan
NG	NATO Green

4 Options

00	No Options
02	Infrared